

ARTEC[®]

MASTER BLENDER MB-1, MB-2

Great Solution for your
Piezo-Mag hybrid guitar and basses

FEATURES

- Input for piezo pickup
- Input for magnetic pickup
- Pickup select switch
- Phase reverse switch for piezo pickup
- Volume and Tone for piezo pickup
- Volume and Tone for magnetic pickup
- Balanced Blender output (XLR)
- Lo-z Blender output jack
- Lo-z Separated output jacks

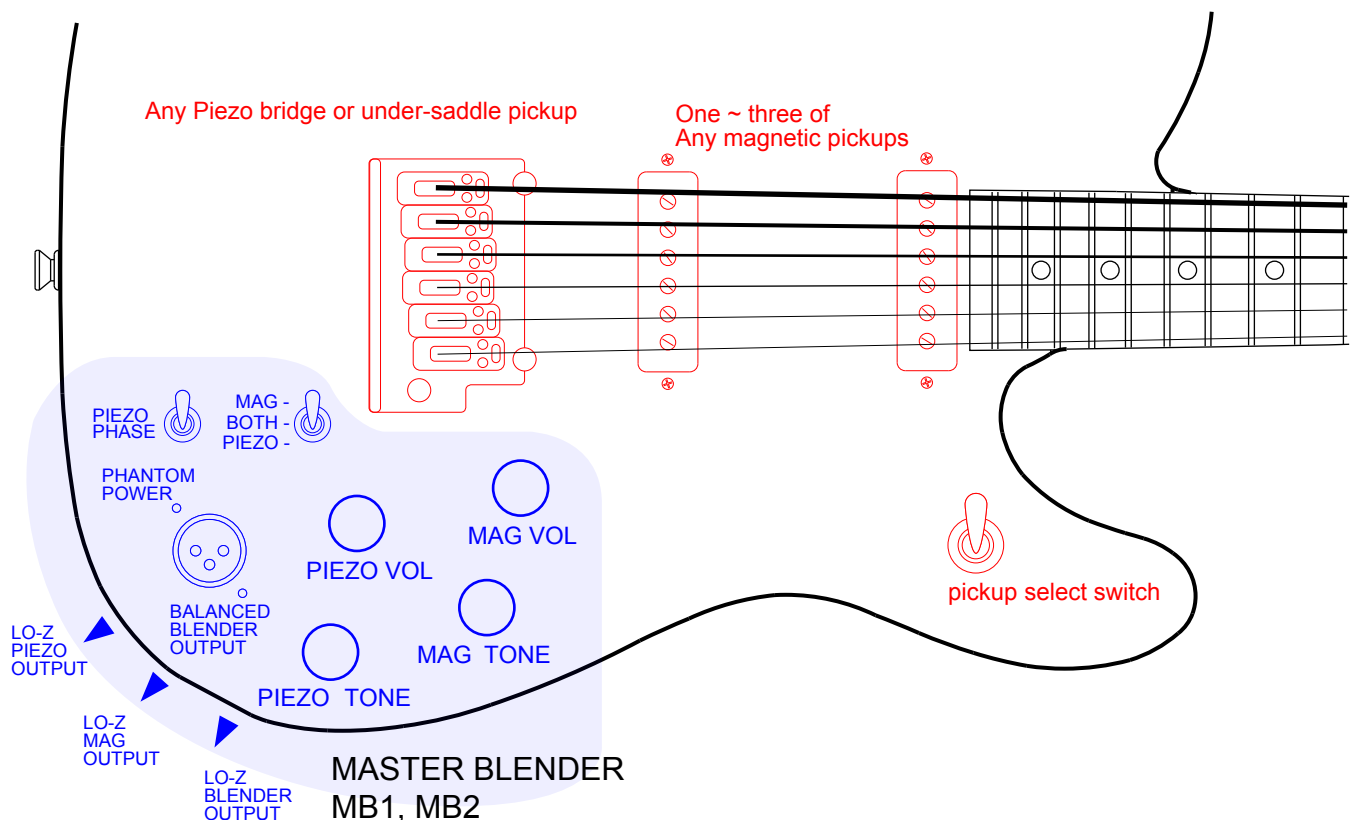

SPECIFICATION :

Dimension (Required space) : 42 x 60 x 20 (mm)

Power requirement : DC 9V (Alkaline Battery)

Supply Voltage range : max 20V, mix 6V

Power consumption : MB-1 : 1.8mA, MB-1 : 1.0mA



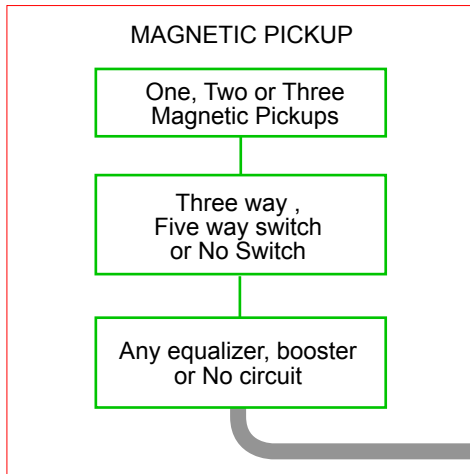

* Design Flexibility

- Piezo tone pot
When remove, tone set as half position.
- Mag tone pot
When remove, tone set as half position. but it can increase treble with VR3 trimmer on circuit board (VR3 should be 0 position when use Mag tone pot)
- Phase and P/U select switch is removable.

* It must use one or more output module

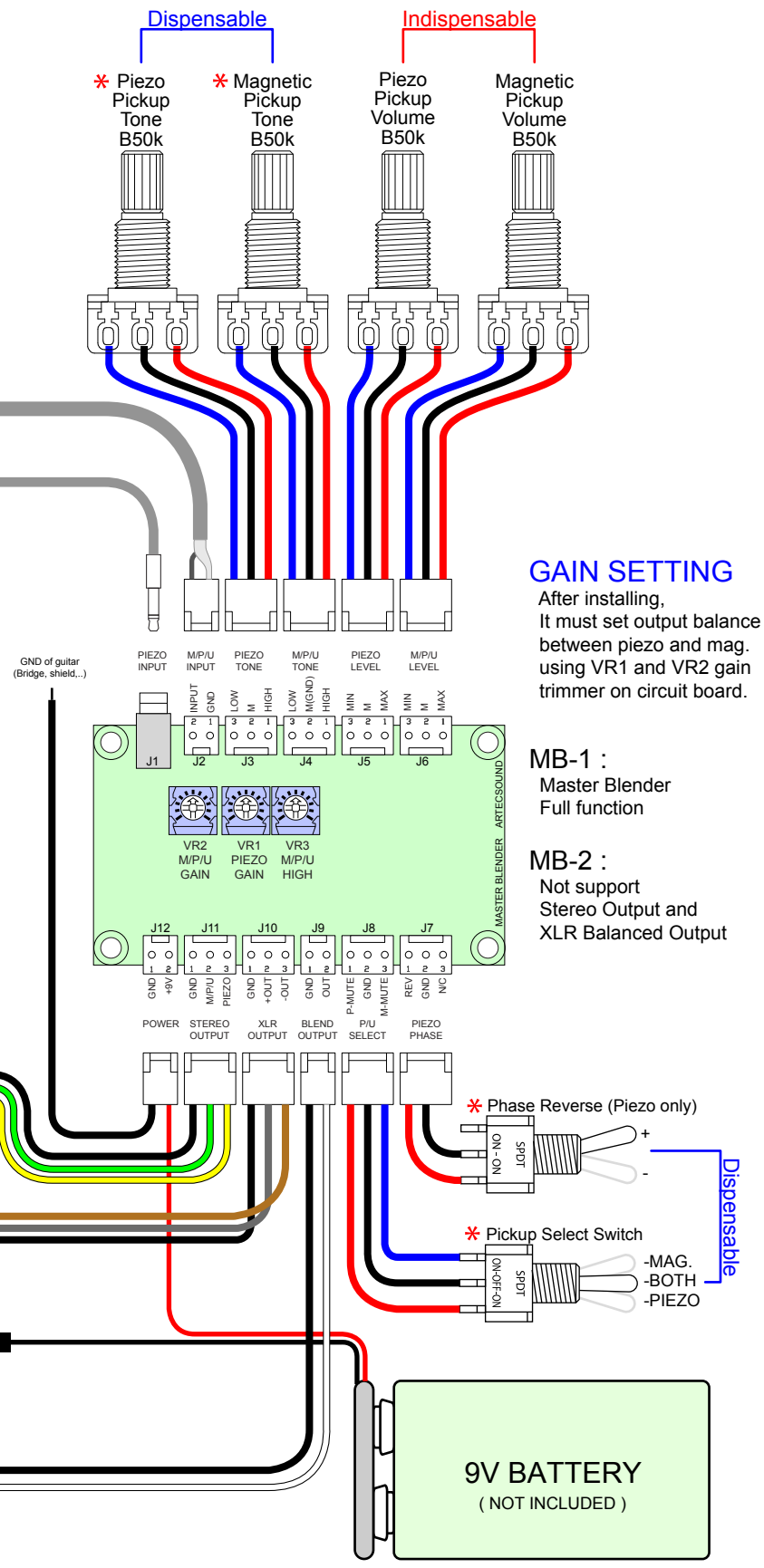
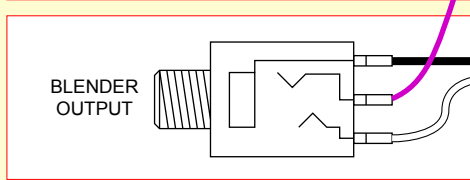
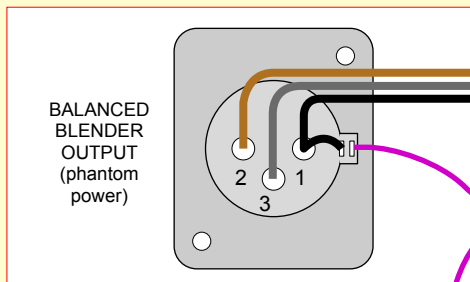
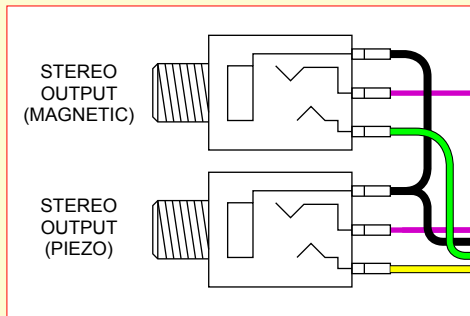

GAIN SETTING



After installing, It must set output balance between piezo and mag. using VR1 and VR2 gain trimmer on circuit board.

MB-1 :
Master Blender Full function

MB-2 :
Not support Stereo Output and XLR Balanced Output

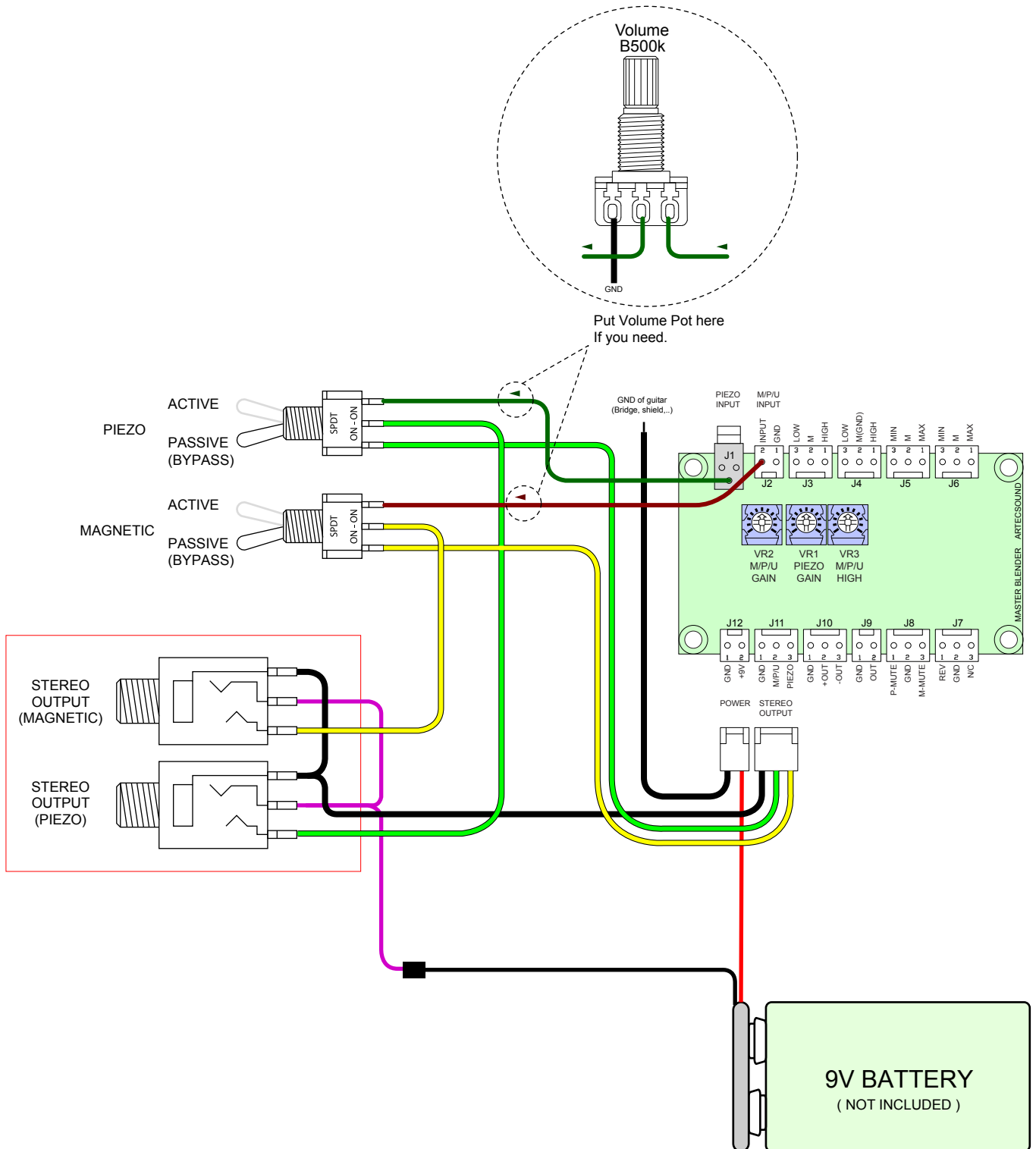
ADD A BYPASS (passive output) SWITCH to each channel

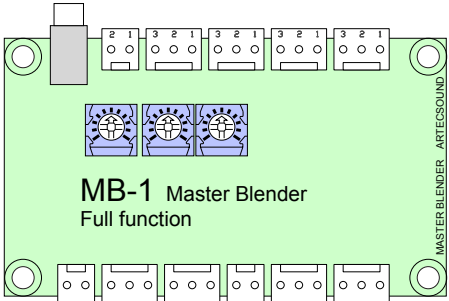
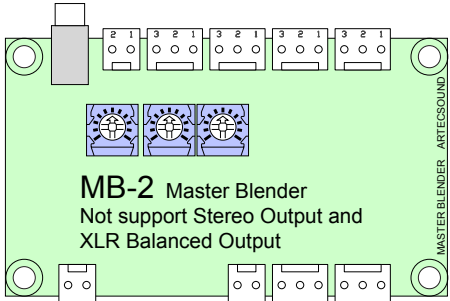
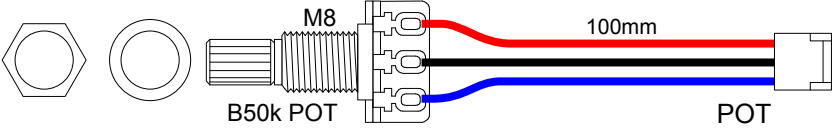
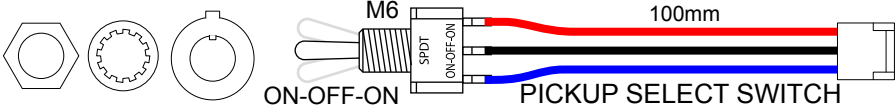
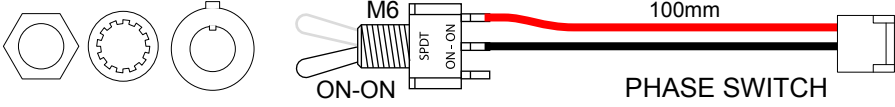
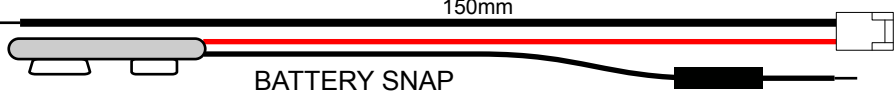

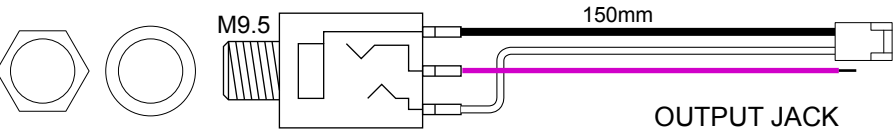
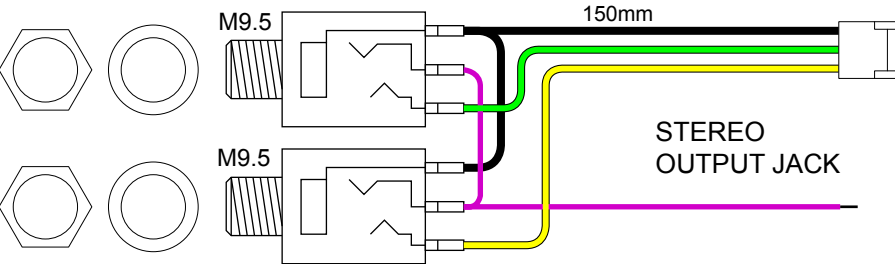
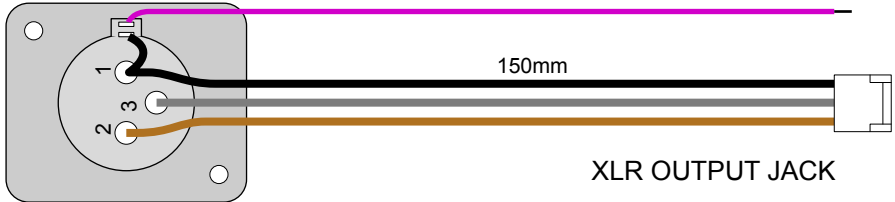
MB-1 COMPLETE KIT		MB-2 COMPLETE KIT	
Quantity			Quantity
1	 <p>MB-1 Master Blender Full function</p>	 <p>MB-2 Master Blender Not support Stereo Output and XLR Balanced Output</p>	1
4	 <p>M8 B50k POT 100mm POT</p>	4	
1	 <p>M6 ON-OFF-ON SPDT 100mm PICKUP SELECT SWITCH</p>	1	
1	 <p>M6 ON-ON SPDT 100mm PHASE SWITCH</p>	1	
1	 <p>150mm BATTERY SNAP</p>	1	
1	 <p>100mm MAGNETIC PICKUP INPUT</p>	1	
1	 <p>M9.5 150mm OUTPUT JACK</p>	1	
1	 <p>M9.5 M9.5 150mm STEREO OUTPUT JACK</p>	0	
1	 <p>150mm XLR OUTPUT JACK</p>	0	

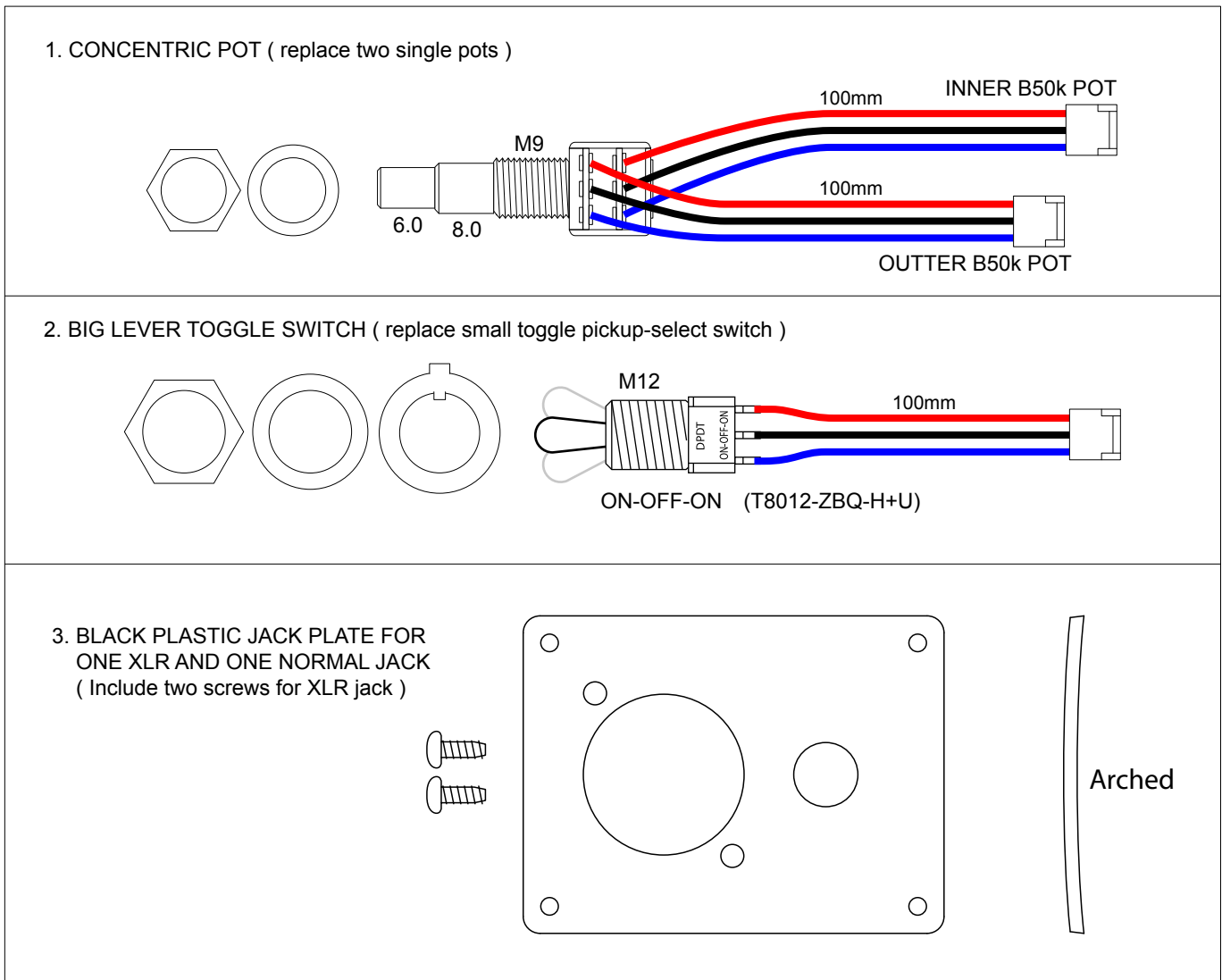

GENERAL CONDITIONS

1. Washer and Nuts include (shown)
2. Battery not included
3. Screw not included
4. Knobs are not included
5. Tone setting was designed with ARTEC's piezo pickup.
6. All metal parts for exterior are chrome or nickel plated.

INSTRUCTION

1. All parts and wiring area must in electrical shielded space to prevent hum and noise.
2. Toggle switch's body connects with ground is recommended.
3. If use metal knob, Also pots body connect with ground is recommended.